

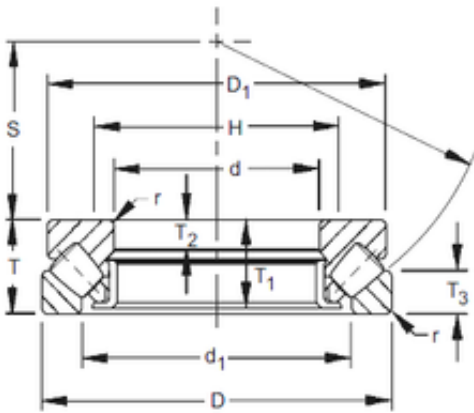

AMERICAN BEARING MFG.CORP.

29388 TIMKEN Tapered Roller Bearings Double-row

Bearing No. 29388



29388 Bearing 2D drawings and 3D CAD models

Size	440x680x145 mm
Bore Diameter	440 mm
Outer Diameter	680 mm
Width	145 mm
d	440 mm
D	680 mm
T	145 mm
B	49 mm
C	69 mm
r max	5,1 mm
T1	140 mm
d1	548 mm
D1	657 mm
H	563 mm
S	246 mm